



ARCHITECTURAL
GRATES + DRAINS



SD90H

Slot Drain



90mm Drain with UPVC Beige Insert

The SD90 features a 25mm opening on the top with 20 slots draining into a concealed 90mm drain pipe with UPVC beige insert.

The PVC insert comes with 10mm holes at 50mm centres .

The Slot Drain can be completed with a 30mm wide architectural wedge-wire grate as an optional item.

Code SD90H

Range Slot Drain

Category Modular Kits

Channel Material uPVC

SPECIFICATIONS + DIMENSIONS

Channel Width	25mm
Channel Depth	Adjustable
Length(s)	3030mm
Outlet Size	N/A

PRODUCT APPLICATIONS

- Commercial Drainage
- Courtyard / Patio Drainage
- Driveway Drainage
- Pool and Spa Area Drainage
- Paved Area Drainage

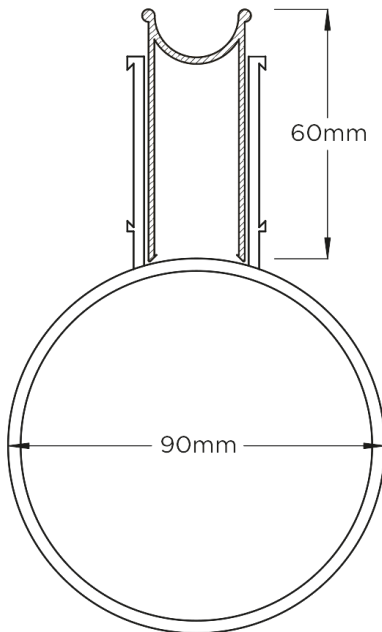

Copyright © Stormtech Pty Ltd. Patent 733361. Drawings not to scale, please use dimensions shown. Downloaded 08/06/2026 (please check for updates)

Grates longer than 1500mm supplied in sections. Tile Inserts longer than 1200mm supplied in sections. Channels over 3000mm supplied in sections with joiner. +/-2mm tolerance on dimensions.



Visit stormtech.com.au
for tools + inspiration.

Phone **1300 653 403**

Email info@stormtech.com.au